

IUI-EZ1

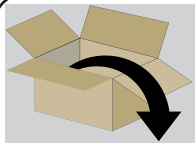

Control Center Installation Guide



IUI-EZ1

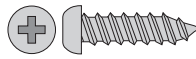

3 -
P/N: 20238



3 -
P/N: 15053



P/N: F01U004749

1

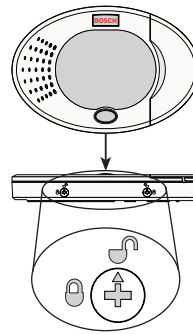

2

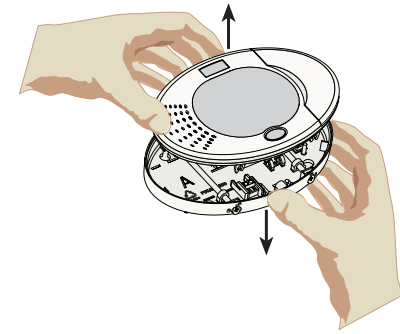

3

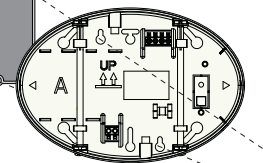
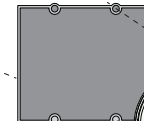
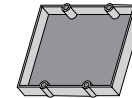
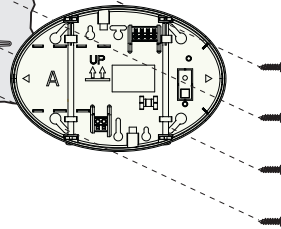
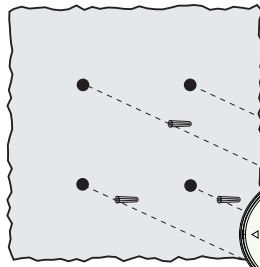
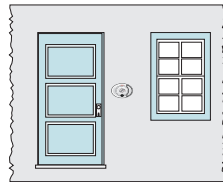
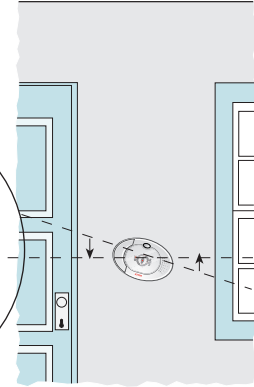
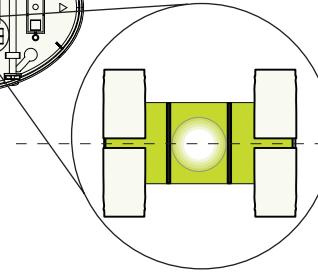
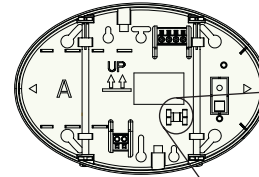

BOSCH

www.boschsecuritysystems.com

© 2006 Bosch Security Systems
F01U003737C

4

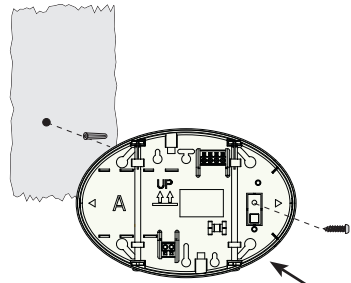

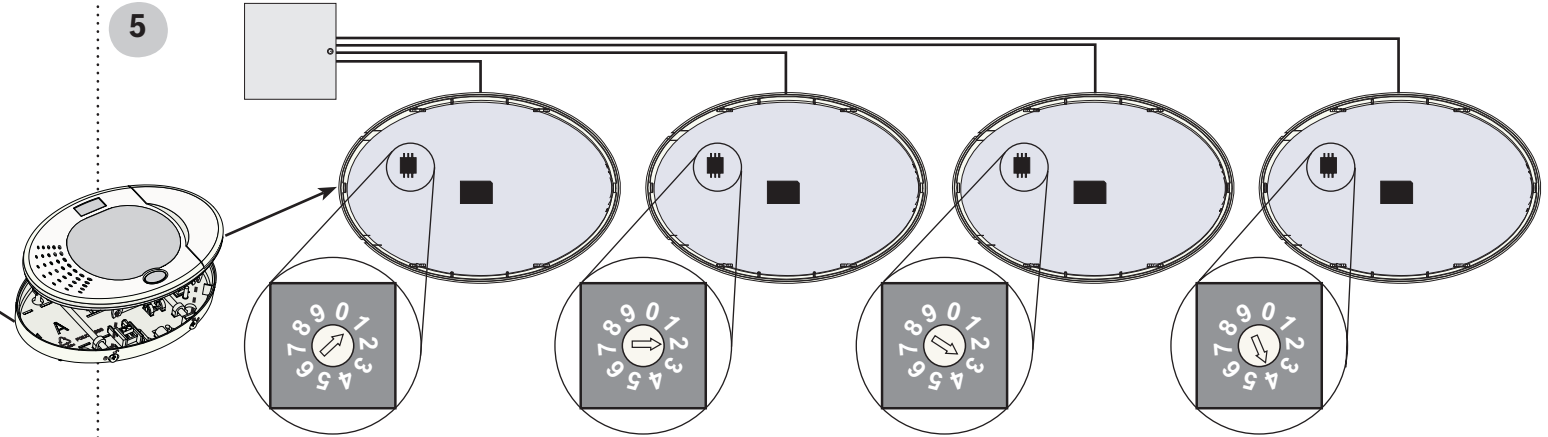

5

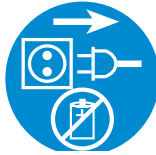
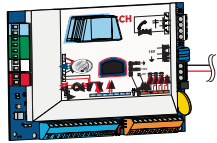

6



I = 105 mA 
 I = 165 mA 
 12 VDC (8 VDC - 14.5 VDC)

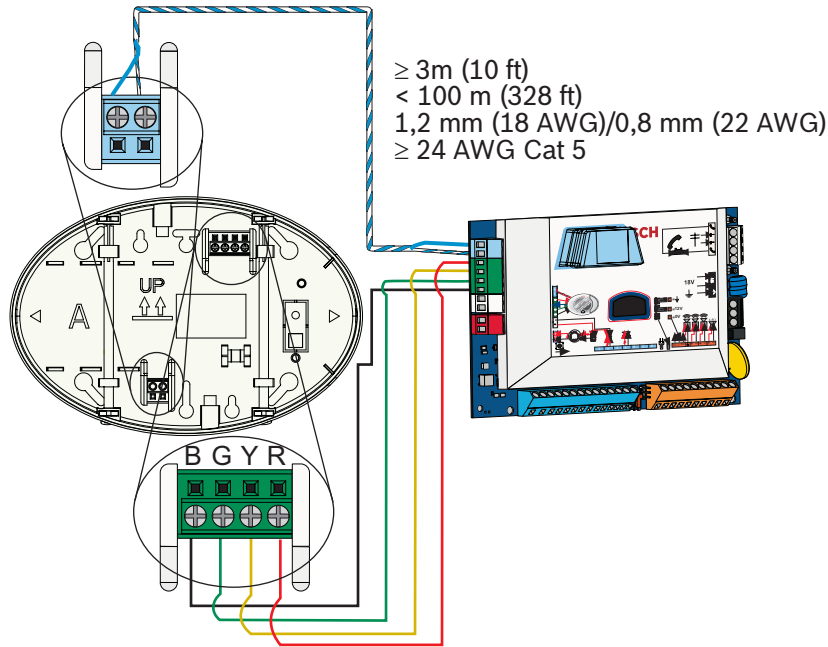

7

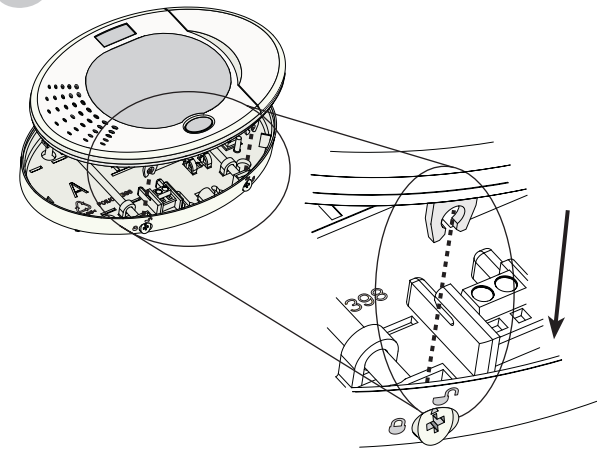

8

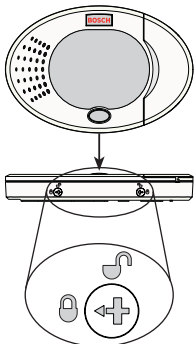

9

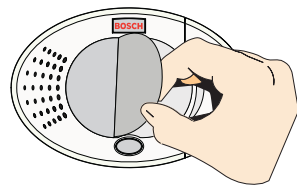

10

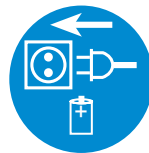
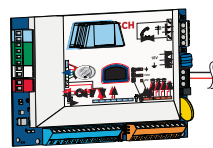

CE
 EN50131-1 Grade 2
 Environmental Class II

© 2006 Bosch Security Systems
 F01U003737C

